



smart
architectural aluminium

Slide 2000

Slide 2000 is the latest innovation in Smart's popular series of elegant sliding doors. An evolution of the original Slide system, Slide 2000 features the signature slim line profiles and minimal sightlines associated with the range.

- U Value 1.6 W/m²K
- Air 600Pa
- Water 250Pa
- Wind 1200Pa

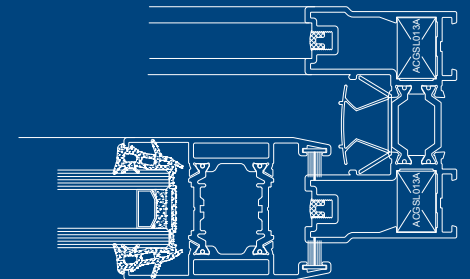
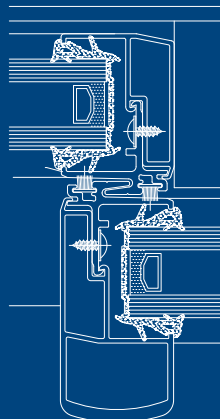
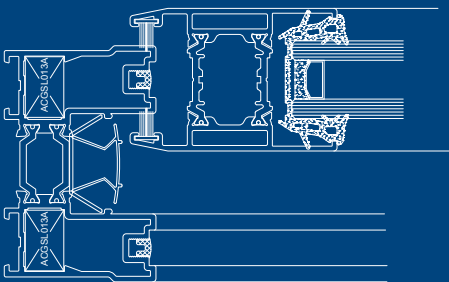

Slide 2000

Slide 2000 is the latest innovation in Smart's popular series of elegant sliding doors and windows. An evolution of the original Slide system using continental style construction, Slide 2000 features the signature slim line profiles and minimal sightlines associated with the range, coupled with modern thermal break technology that provides consumers with both enhanced thermal performance and the option of dual colour profiles in a wide choice of colour finishes. The system is designed for use as sliding patio doors in residential applications for both new build homes and refurbishment projects. Slide 2000 is also suitable for use as horizontal sliding windows for light commercial use such as external serving hatches in restaurants. Sliding windows are also ideal for applications where increased ventilation is required. The window offers a solution where applications, such as schools and hospitals, require an opensash that does not project creating an obstruction.

Slide 2000 uses a selection of mitred outer frames featuring a dual or triple track option allowing the choice of 2, 3 or 4 pane doors. Two pane doors can have either dual sliding sashes or a fixed pane & one sliding opening sash configuration. If fitted with a triple track threshold all three sliding sashes can be configured to slide to one side which gives a 2/3 opening aperture.

The sliding door sets are fitted with a multi-point locking, one piece lock keep that offers enhanced security and ease of fabrication. Smaller horizontal sliding windows can also be fitted with single point locking mechanisms. Fabrication of the outer frame is by method of mechanical cleats with Smart punch tooling providing rapid and accurate fabrication.

Slide 2000 doors will accept 24mm, 28mm or 32mm double or triple glazed sealed units. Glass units are secured using a wrap-around gasket with the sash profiles assembled around the sealed unit.

Technical Performance

U Value	1.6 W/m ² K
Air	600Pa
Water	250Pa
Wind	1200Pa
Document L Compliant	
Glass	24mm, 28mm or 32mm
Dual Colour	Yes
Security	Multi-point lock (sliding door) Single point lock (Horizontal sliding window)*

Dimensions

Max Sash Weight	200kg
Max Sash Height	2100mm
Min Sash Weight	382mm*
Min Sash Height	Providing the sashes are within the above limitations there is no maximum width

*Single point lock for smaller height

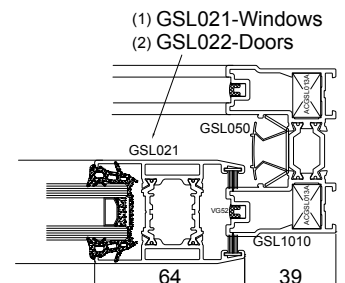
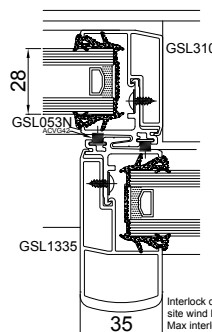
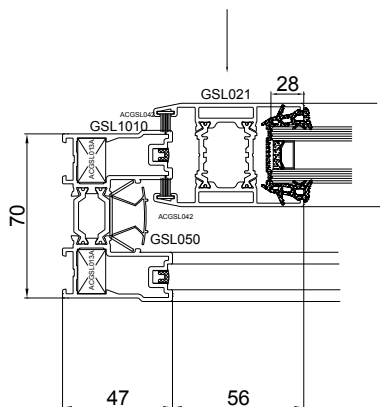
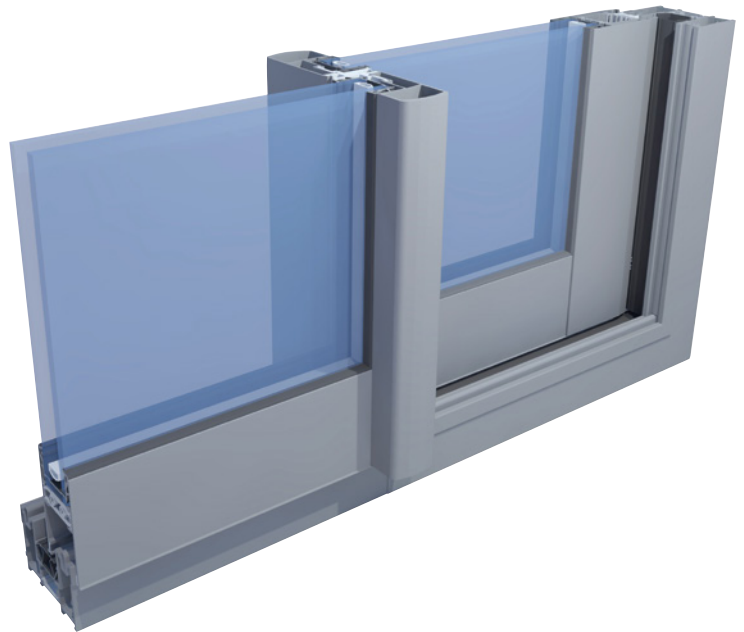

Interlock depth may change depending on size and site wind load
Max interlock width is 36.5mm

Smart Systems Limited

Arnolds Way | Yatton | Bristol | North Somerset | BS49 4QN | UK

T +44 (0) 1934 876 100 | F +44 (0) 1934 835 169 |

W www.smartsystems.co.uk | E sales@smartsystems.co.uk

IMS127SL2.201504

The images, drawings and data shown in this brochure are for illustrative purposes only and are not binding in detail, colour or specification. We reserve the right to make changes to the product specification as technical developments dictate and without prior notice. We recommend that the user ensures that they are satisfied the product meets their requirements prior to purchase. ©Smart Systems Ltd 2014